

arches

Square

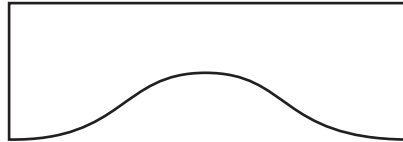

Standard



Shallow

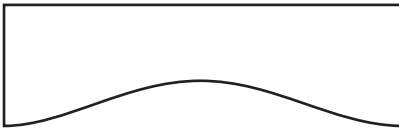

Gentle Arch



"V" Top



Hudson

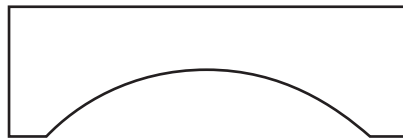

French

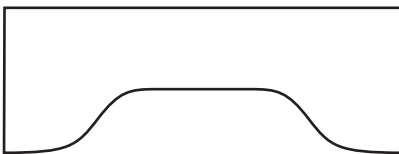

inside

Bead



Ogee



Roundover

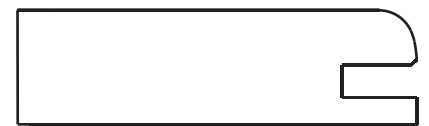

Shaker



Bevel*



*Note: On Bevel V Groove runs through the joint

Cove



Eased Shaker*

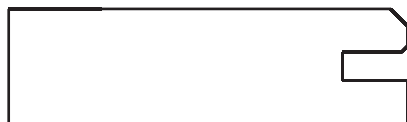

*Note: On Eased Shaker V Groove does not run through the joint

Chamfer

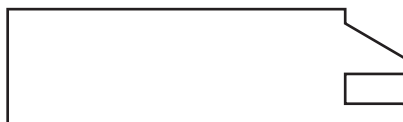

8 Mod



inside

Shaker*



*Note: 1/4" reveal on face.



panel raise

Acadia



Beardsley

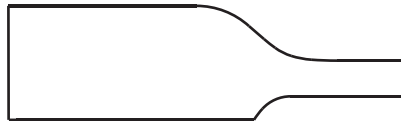

Celtic



Empire



Huguenot



Harvard



Jubilee



JMod



Kipling



Liberty



Normandy

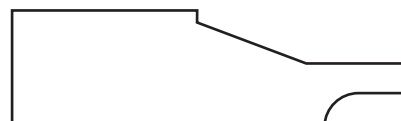

NMod

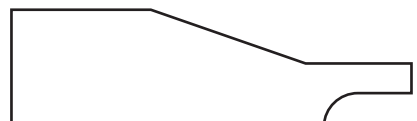

panel raise

Winston

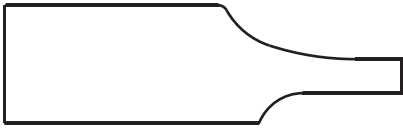

Solid



Solid V Groove



Solid Bead



Plywood

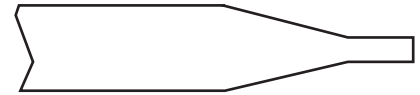
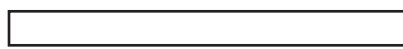



outside

1/4 Cove

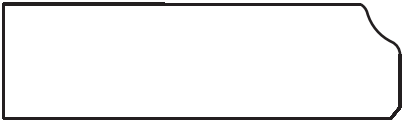

Ogee

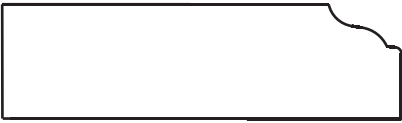

1/4 Roundover

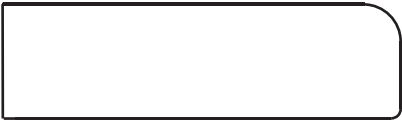

Bead



Eased Bead



1/8 Cove



Bevel



Chamfer



Square



outside

Eased Square



3/8 Roundover

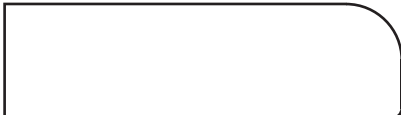

Bullnose



Cove

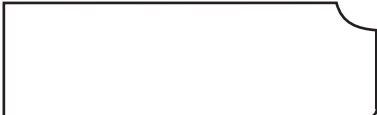

mitre

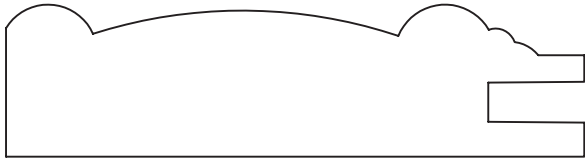

2100

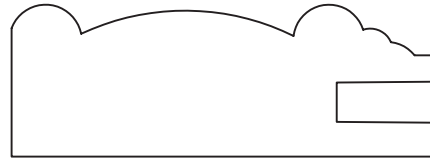

2150

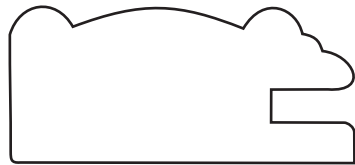

2175

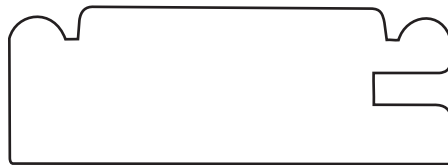

2200

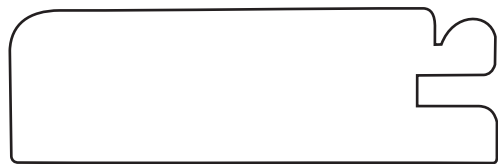

2250

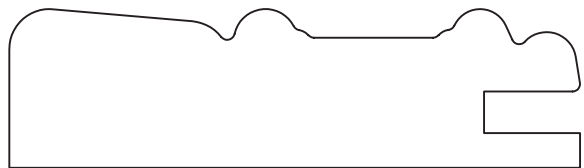

2300

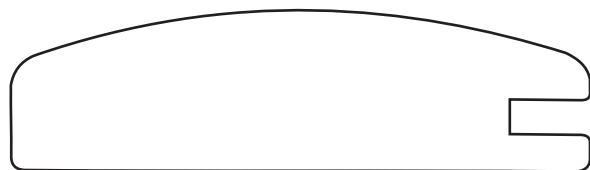

2400

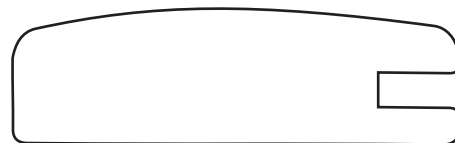

2450

mitre

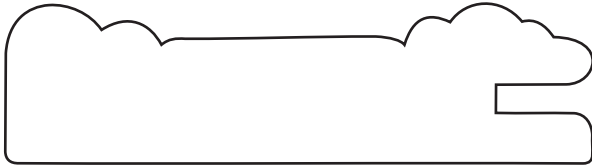

2500

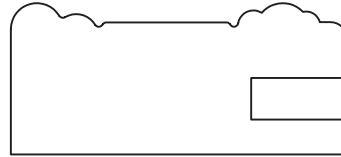

2575

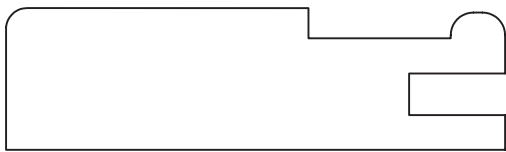

2600

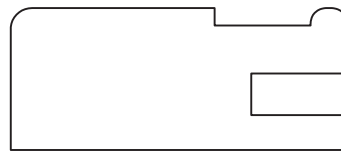

2675

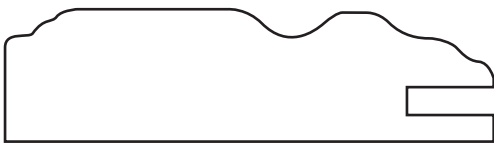

2700



2800

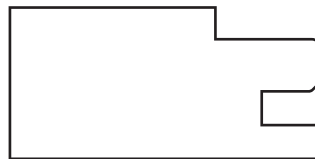

2875

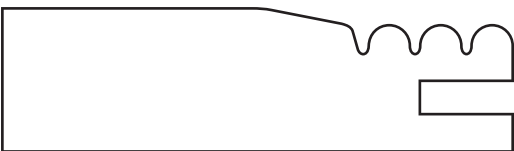

2900



2950

mouldings

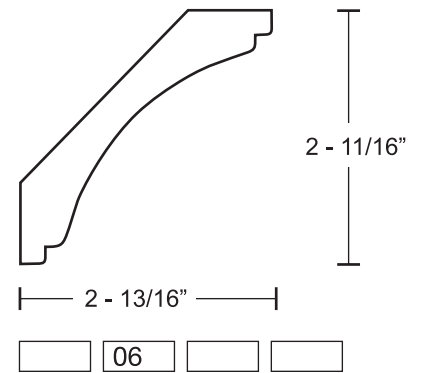
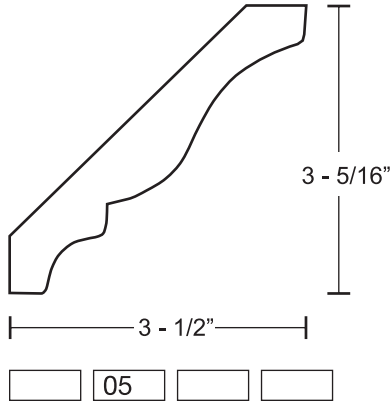
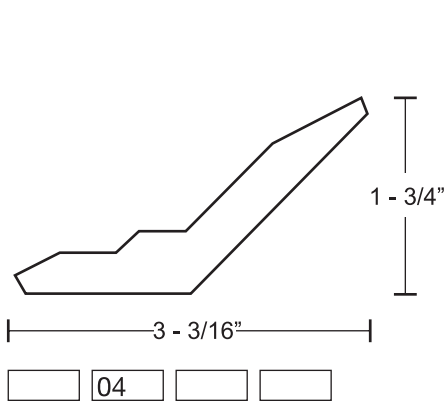
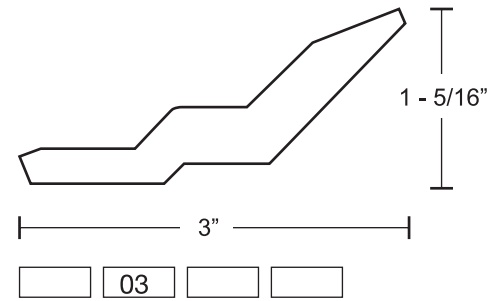
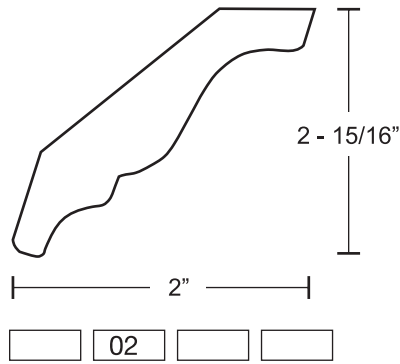
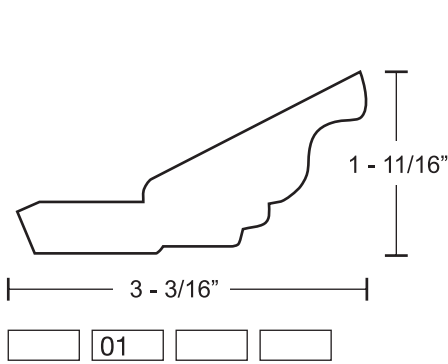

mouldings

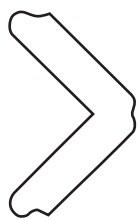
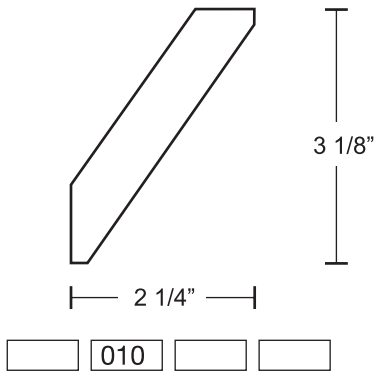
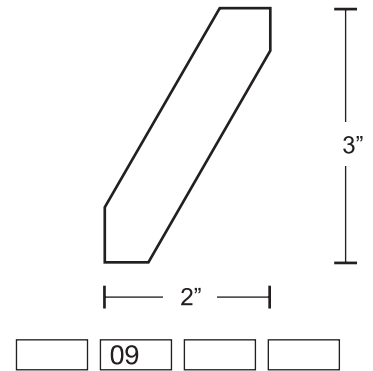
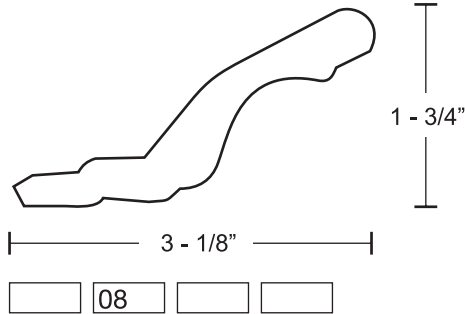
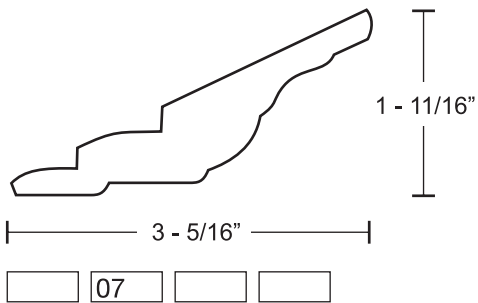

90° Corner



45° Corner

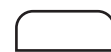

Batten

